

Article number: 03440008

Description: Fluro Rod end GE 8EC

## Measures

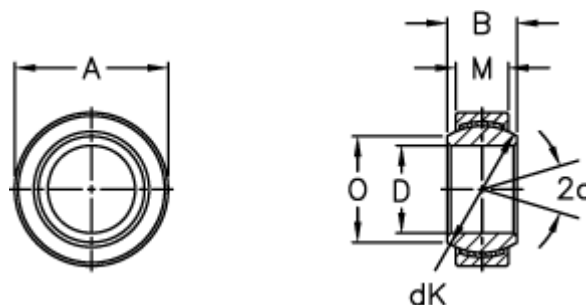

A	= 16 0 -0,008	Tilt angle = 15
B	= 8	Weight = 7
D	= 8 0 -0,008	
dK	= 13	
Dynamic load C (kN)	= 5.8	
M	= 5	
O	= 10.2	
Static load C0 (kN)	= 14.6	